

CC

MABBLAETTER
DIMENSIONS
ENCOMBREMENTS



Ösenaufhängung mit PM SYSTEM Schiebefahrwerk (Quer zur Kettenzugachse)
Fixed to manual push trolley with PM SYSTEM (perpendicular version)
Accouplé à chariot manuel PM SYSTEM (version perpendiculaire)

UKA30 - UKA40
MAX 1000 Kg

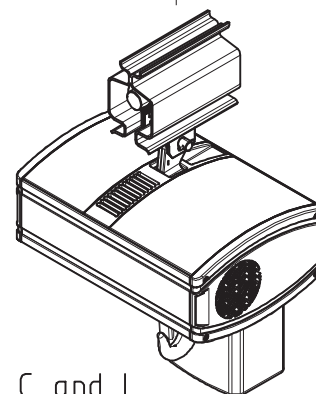
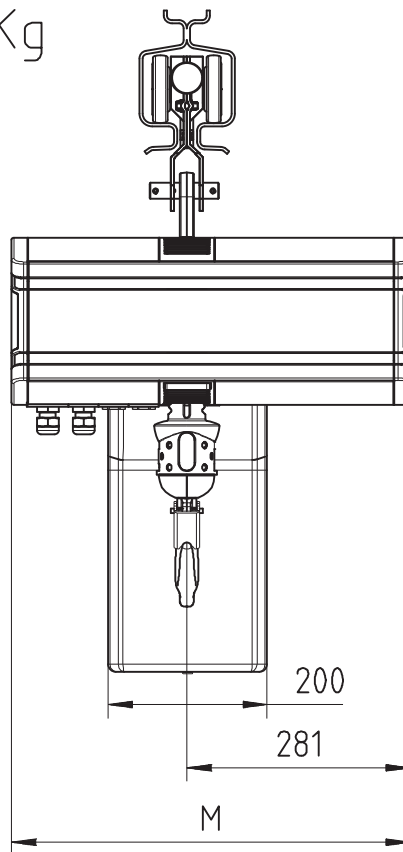
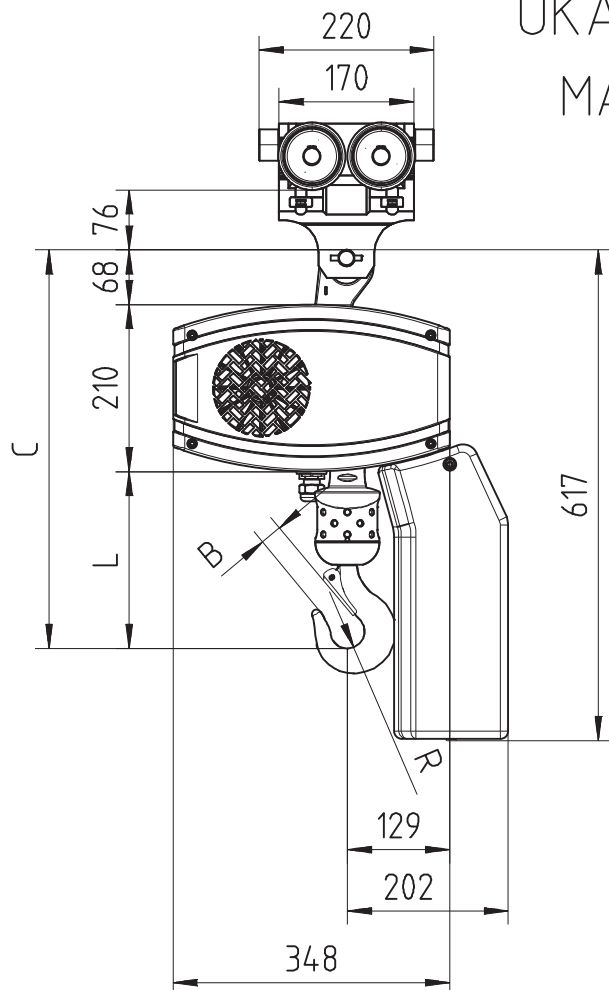

Note: For hoisting speed 16m/min and higher, add 63 mm to Dimension C and L.

Chain Size in mm	Max load kg	Chain bag capacity	Dimensions in mm				Weight of 3m chain	Total weight w/o chain			
			B	C	L	R		Classic	GT	GLS	DB
5x14	630	12m	21	449	171	17	1.78	55.4	60.9	59.8	58.1
7X20	1000	10m	28	501	223	21	3.36	501	615	590	539
Dimension M in mm								501	615	590	539

GLS: Gear Limit Switch
DB : Double Brake

SWF behält sich das Recht auf Veränderung oder Richtigstellung der oben genannten Information ohne weitere Mitteilung vor.
SWF reserves the right to alter or amend the above information without notice.
SWF se réserve le droit de modifier sans préavis les caractéristiques de son matériel.
DISCLOSED WITHOUT PRIOR WRITTEN CONSENT OF THE COMPANY . ANY COPIES OF THIS DOCUMENT MADE BY ANY METHOD MUST ALSO INCLUDE A COPY OF THIS LEGEND.

53109217
D166902-A
19/10/2012